

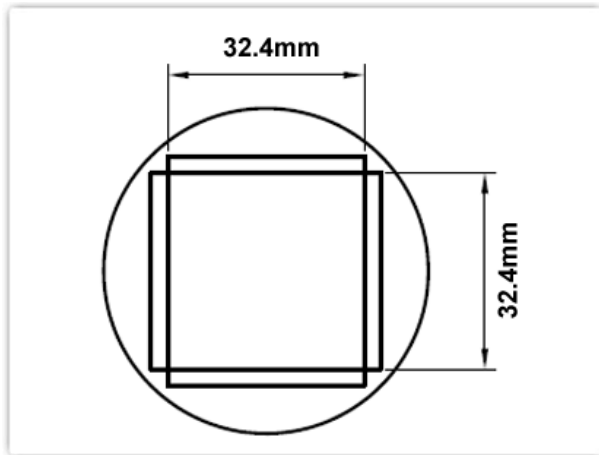

HTN-PL84

熱風槍嘴



HTN-PL84

ESD FREE LEAD FREE

熱風槍嘴 32.4mm x 32.4mm, PLCC-84

- ▶ 熱風嘴形狀: PLCC-84
- ▶ 熱風嘴寬度: 32.40mm (1.28")
- ▶ 熱風嘴高度: 32.40mm (1.28")

描述

Thermaltronics HTN系列熱風嘴性能卓越，經久耐用。適用於標準接頭直徑為 22 毫米 (0.87") 的熱風工具。

技術參數

熱風嘴系列:	HTN系列
RoHS 標準 ¹ / Lead Free:	符合
兼容產品型號:	H-P84
適用於:	TMT-HA050, TMT-HA200, TMT-HA300, TMT-HA600, HCT-900, 標準熱風槍

材料成份

Stainless Steel



All components are RoHS compliant and Lead-Free.



Standard Connector
22mm (0.87") diameter

¹ 請參閱 European Commission 了解 RoHS 標準.