

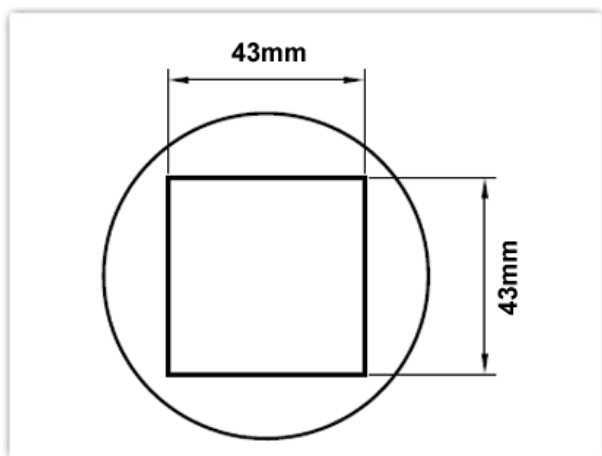

# HTN-B4343

熱風槍嘴



**HTN-B4343**

**ESD  
FREE**

**LEAD  
FREE**

熱風槍嘴 43.0mm x 43.0mm, BGA

- ▶ 熱風嘴形狀: BGA
- ▶ 熱風嘴寬度: 43.00mm (1.69")
- ▶ 熱風嘴高度: 43.00mm (1.69")

## 描述

Thermaltronics HTN系列熱風嘴性能卓越，經久耐用。適用於標準接頭直徑為 22 毫米 (0.87") 的熱風工具。

## 技術參數

熱風嘴系列:	HTN系列
RoHS 標準 <sup>1</sup> / Lead Free:	符合
適用於:	TMT-HA050, TMT-HA200, TMT-HA300, TMT-HA600, HCT-900, 標準熱風槍

## 材料成份

Stainless Steel



**All components  
are RoHS  
compliant and  
Lead-Free.**

**Standard Connector  
22mm (0.87") diameter**

<sup>1</sup> 請參閱 European Commission 了解 RoHS 標準.