

HTN-B3030 Datasheet

Technical Specifications

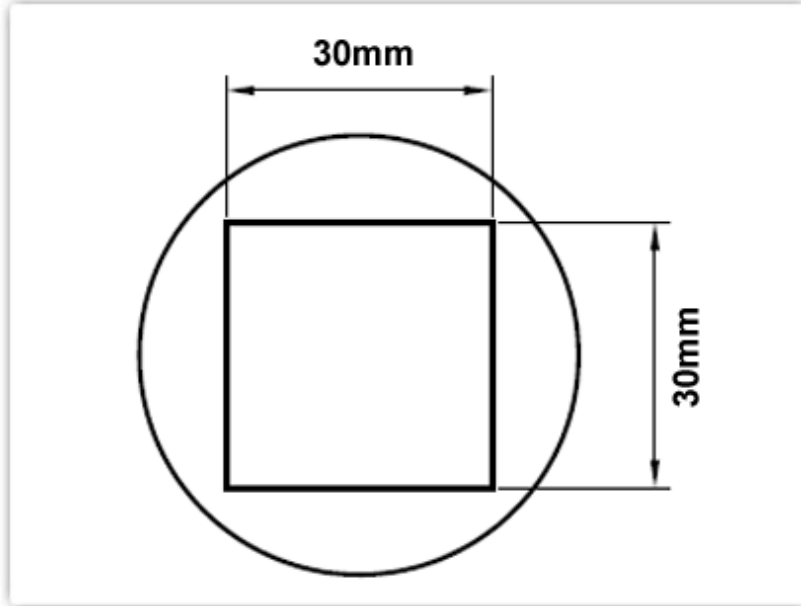

HTN-B3030

Nozzle 30.0mm x 30.0mm, BGA

Nozzle Style: BGA

Nozzle Width: 30.00mm (1.18")

Nozzle Height: 30.00mm (1.18")

Nozzle Type:	HTN Series
RoHS Compliant / Lead Free:	YES
For Use With:	TMT-HA200, TMT-HA300, HCT-900

Material Composition

Stainless Steel



***All components
are RoHS
compliant and
Lead-Free.***



**Standard Connector
22mm (0.87") diameter**