

# H60-WD08 Datasheet

## Technical Specifications

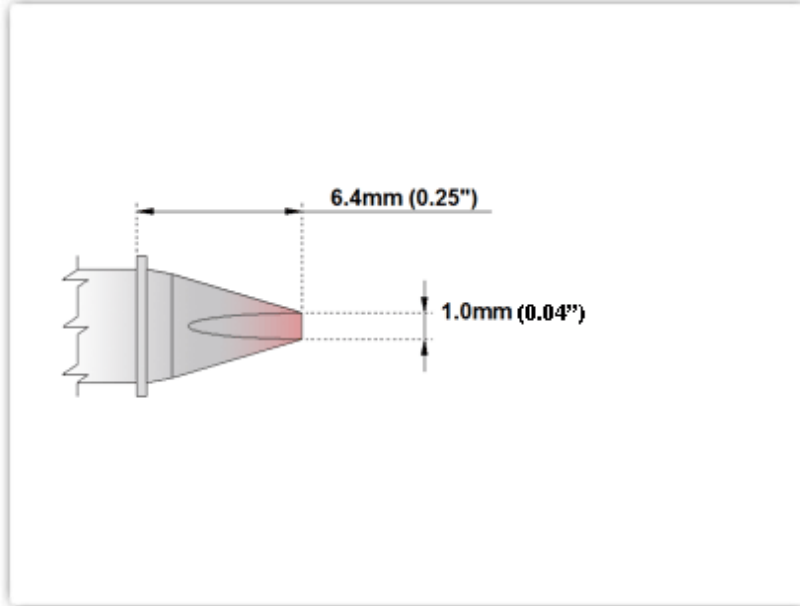

### H60-WD08

**Chisel 30° 1.0mm (0.04")**

Tip Style: Chisel 30°

Tip Width: 1.00mm (0.04")

Tip Length: 6.40mm (0.25")

600 Type Cartridge<sup>1</sup>:

RoHS Compliant<sup>2</sup> / Lead Free:

Equivalent to:

For Use With:

325°C - 358°C

YES

T31-03WD08

FX-100

## Material Composition

## Patented Color Band

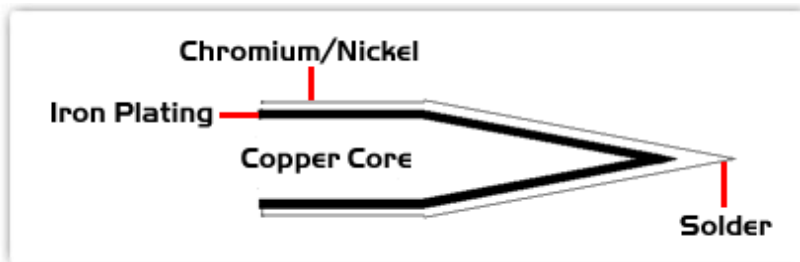

**All components  
are RoHS  
compliant and  
Lead-Free.**

<sup>1</sup> Thermaltronics tip cartridges will typically idle within a temperature range of +/-1.1°C. However, there is variation in idle temperature across tip geometries within an individual temperature series. Thermaltronics offers a wide variety of tip geometries from 0.25mm fine point tip to 5mm chisel. The length and geometry of a tip will have an influence on the tip idle temperature. To accurately measure idle temperature it will depend greatly on the measurement method, technique and equipment used. Two different methods or the use of alternative equipment will produce different test results.

<sup>2</sup> Please refer to <http://www.rohs.gov.uk> for details on RoHS Compliance.