

HTN-SJ40 Datasheet

Technical Specifications

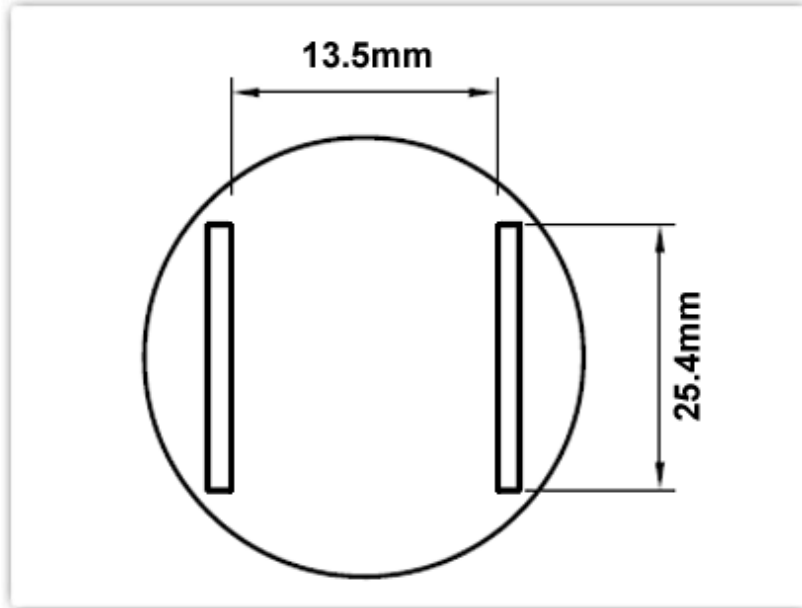

HTN-SJ40

Nozzle 13.5mm x 25.4mm, SOJ 40

Nozzle Style: SOJ 40

Nozzle Width: 13.50mm (0.53")

Nozzle Height: 25.40mm (1.00")

Nozzle Type:	HTN Series
RoHS Compliant / Lead Free:	YES
Equivalent to:	H-SOJ40
For Use With:	TMT-HA200, TMT-HA300, HCT-900

Material Composition

Stainless Steel



***All components
are RoHS
compliant and
Lead-Free.***



**Standard Connector
22mm (0.87") diameter**