

## HTN-PL52 Datasheet

### Technical Specifications

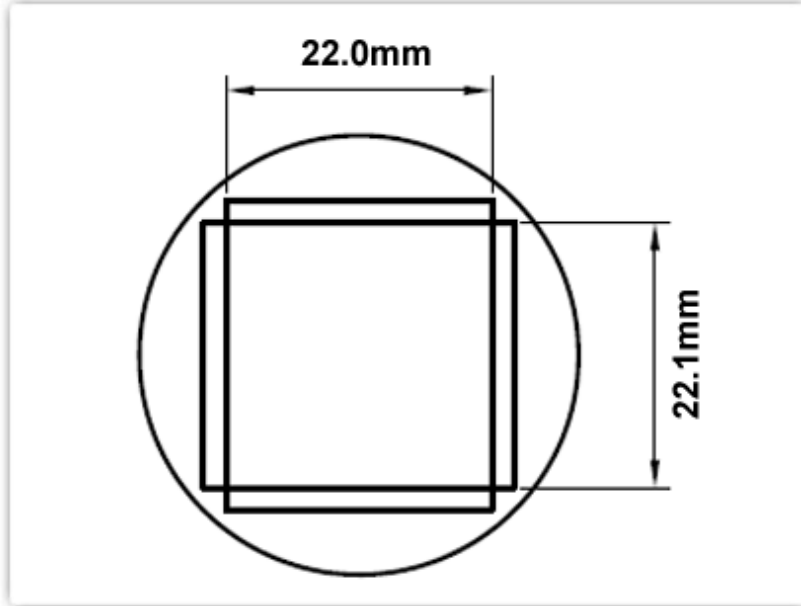

#### HTN-PL52

*Nozzle 22.0mm x 22.1mm, PLCC-52*

Nozzle Style: PLCC-52

Nozzle Width: 22.00mm (0.87")

Nozzle Height: 22.10mm (0.87")

Nozzle Type:	HTN Series
RoHS Compliant / Lead Free:	YES
Equivalent to:	H-P52
For Use With:	TMT-HA200, TMT-HA300, HCT-900

### Material Composition

**Stainless Steel**



**All components  
are RoHS  
compliant and  
Lead-Free.**



**Standard Connector  
22mm (0.87") diameter**