

## HTN-PL28 Datasheet

### Technical Specifications

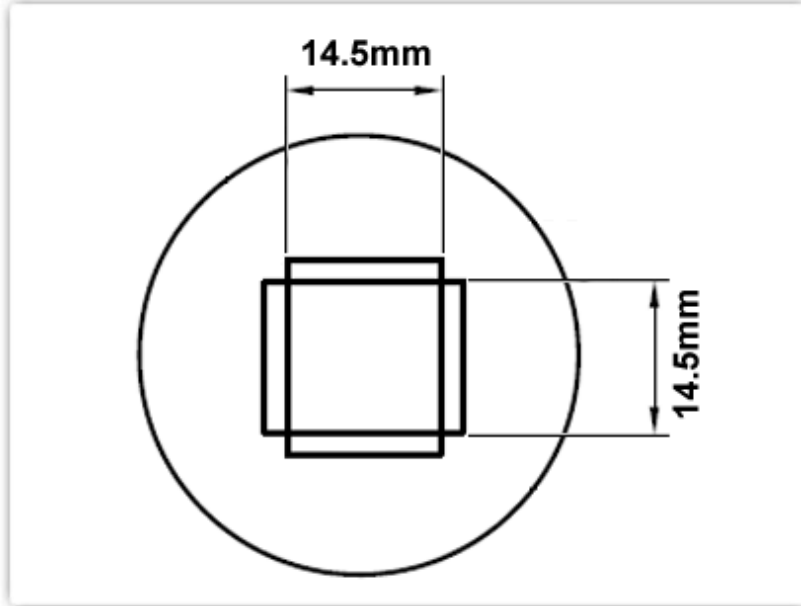

#### HTN-PL28

*Nozzle 14.5mm x 14.5mm, PLCC-28*

Nozzle Style: PLCC-28

Nozzle Width: 14.50mm (0.57")

Nozzle Height: 14.50mm (0.57")

Nozzle Type:	HTN Series
RoHS Compliant / Lead Free:	YES
Equivalent to:	H-P28
For Use With:	TMT-HA200, TMT-HA300, HCT-900

### Material Composition

**Stainless Steel**



**All components  
are RoHS  
compliant and  
Lead-Free.**



**Standard Connector  
22mm (0.87") diameter**