

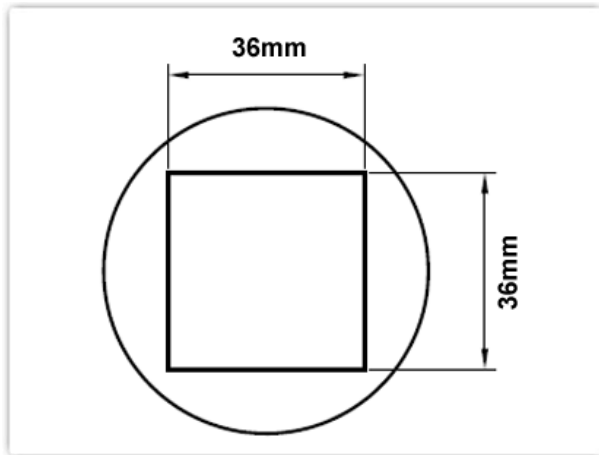

HTN-B3636

熱風槍嘴



HTN-B3636

**ESD
FREE**

**LEAD
FREE**

熱風槍嘴 36.0mm x 36.0mm, BGA

- ▶ 熱風嘴形狀: BGA
- ▶ 熱風嘴寬度: 36.00mm (1.42")
- ▶ 熱風嘴高度: 36.00mm (1.42")

描述

Thermaltronics HTN系列熱風嘴性能卓越，經久耐用。適用於標準接頭直徑為 22 毫米 (0.87") 的熱風工具。

技術參數

熱風嘴系列:	HTN系列
RoHS 標準 ¹ / Lead Free:	符合
適用於:	TMT-HA050, TMT-HA200, TMT-HA300, TMT-HA600, HCT-900, 標準熱風槍

材料成份

Stainless Steel



**All components
are RoHS
compliant and
Lead-Free.**

**Standard Connector
22mm (0.87") diameter**

¹ 請參閱 European Commission 了解 RoHS 標準.