

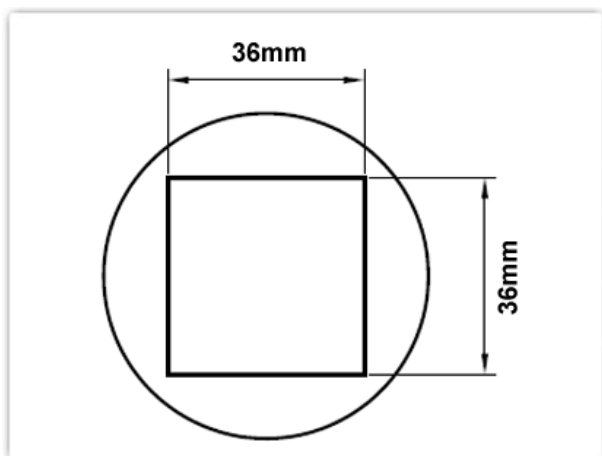

HTN-B3636

热风枪嘴



HTN-B3636

**ESD
FREE**

**LEAD
FREE**

热风枪嘴 36.0mm x 36.0mm, BGA

- ▶ 热风嘴形状: BGA
- ▶ 热风嘴宽度: 36.00mm (1.42")
- ▶ 热风嘴高度: 36.00mm (1.42")

描述

Thermaltronics HTN系列热风嘴性能卓越，经久耐用。适用于标准接头直径为 22 毫米 (0.87") 的热风工具。

技术参数

热风嘴系列:	HTN系列
RoHS 标准 ¹ / Lead Free:	符合
适用于:	TMT-HA050, TMT-HA200, TMT-HA300, TMT-HA600, HCT-900, 标准热风枪

材料成份

Stainless Steel



**All components
are RoHS
compliant and
Lead-Free.**

**Standard Connector
22mm (0.87") diameter**

¹ 请参阅 European Commission 了解 RoHS 标准.