

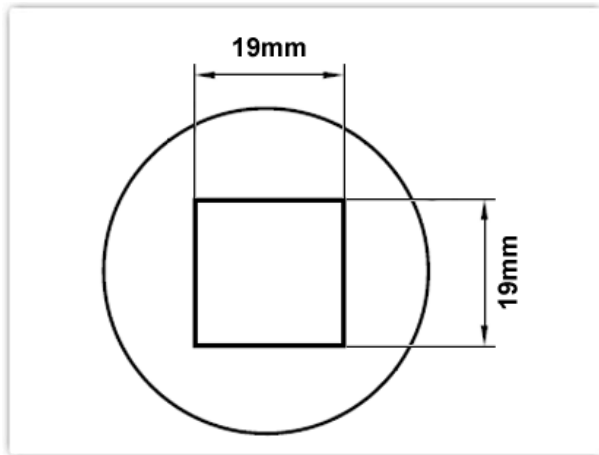

HTN-B1919

热风枪嘴



HTN-B1919

**ESD
FREE**

**LEAD
FREE**

热风枪嘴 19.0mm x 19.0mm, BGA

- ▶ 热风嘴形状: BGA
- ▶ 热风嘴宽度: 19.00mm (0.75")
- ▶ 热风嘴高度: 19.00mm (0.75")

描述

Thermaltronics HTN系列热风嘴性能卓越，经久耐用。适用于标准接头直径为 22 毫米 (0.87") 的热风工具。

技术参数

热风嘴系列:	HTN系列
RoHS 标准 ¹ / Lead Free:	符合
适用于:	TMT-HA050, TMT-HA200, TMT-HA300, TMT-HA600, HCT-900, 标准热风枪

材料成份

Stainless Steel



**All components
are RoHS
compliant and
Lead-Free.**



**Standard Connector
22mm (0.87") diameter**

¹ 请参阅 European Commission 了解 RoHS 标准.